

HF 3CFHF



Push-pull female couplings for agriculture with higher flow rate, up to 250 l/min.

Push-pull female couplings for high flow rate applications, connectable with male under residual pressure. Breakaway function. Can be screwed directly into valve ports or rigid pipes. ISO 7241 part A interchange. Flow rate up to 250 l/min.



Applications



Pressure Drop

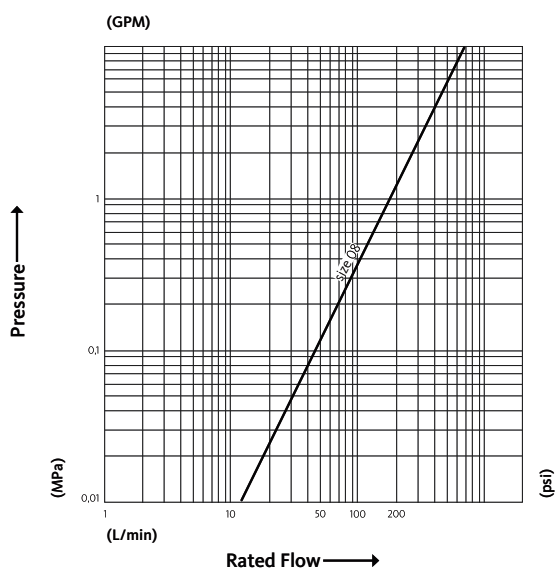

Test performed according to ISO 18869

Technical Specifications

dash	Size		Working Pressure (MPa)	Flow Rate (l/min)	Spillage (ml)	Force to Connect (N)	Burst pressure (MPa)		
	mm	inch					Male	Female	Male + Female
08	12.5	1/2"	25	70	2	250	100	110	

Material	Steel
Seals	PUR
Working temperatures	- 25 °C to + 100 °C
Surface treatment	MATE 500 (CrIII)
Series Interchange	ISO 7241 part A

Valve Type	Poppet
Connection	Push to Connect
Disconnection	Pull to Disconnect
Connection Under Pressure	Allowed Male Half up to W.P.



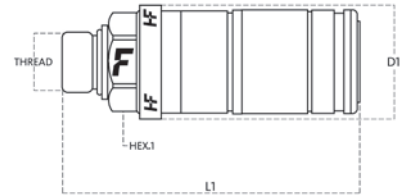

3CFHF

Size		Thread details			FEMALE						
mm	inch	Thread Type	Standard	Thread	Part Number	L (L1 + Thread)		D1		HEX1	
						mm	inch	mm	inch	mm	inch
12.5	1/2"	01/ SAE	ISO 11926-3	3/4"-16 UNF MALE	3CFHF081/12SAE F	108.2	4.26	42	1.65	32	1.26
12.5	1/2"	07/ METRIC	ISO 8434-1-L	M22x1.5 MALE BULKHEAD SHORT 15L	3CFHF087/2215 F	122.4	4.82	42	1.65	32	1.26
12.5	1/2"	07/ METRIC	ISO 8434-1-L	M18x1.5 MALE BULKHEAD SHORT 12L	3CFHF087/1815 F	121.2	4.77	42	1.65	32	1.26
12.5	1/2"	19/ METRIC	DIN 7642	M22x1.5 MALE	3CFHF0819/2215 F	134.7	5.3	42	1.65	32	1.26
12.5	1/2"	F NPTF	ANSI B1.20.3	NPTF 1/2" FEMALE	3CFHF08 12NPT F	106.2	4.18	42	1.65	27	1.06
12.5	1/2"	F BSPP	ISO 1179-1	BSPP 1/2" FEMALE	3CFHF08 12GAS F	106.2	4.18	42	1.65	27	1.06
12.5	1/2"	01/ METRIC	ISO 6149-2	M22x1.5 MALE	3CFHF081/2215 F	109.7	4.32	42	1.65	32	1.26
12.5	1/2"	01/ METRIC	ISO 6149-2	M18x1.5 MALE	3CFHF081/1815 F	112.2	4.42	42	1.65	32	1.26
12.5	1/2"	21/ METRIC	ISO 9974-2	M22x1.5 MALE	3CFHF0821/2215 F	109.2	4.3	42	1.65	32	1.26
12.5	1/2"	21/ METRIC	ISO 9974-2	M22x1.5 MALE	3CFHF21/22F U	109.2	4.3	42	1.65	32	1.26
12.5	1/2"	14/ SAE	ISO 8434-2	7/8"-14 UNF MALE BULKHEAD JIC	3CFHF14/78UNFF	127.7	5.03	42	1.65	32	1.26
12.5	1/2"	14/ SAE	ISO 8434-2	3/4"-16 UN MALE BULKHEAD JIC	3CFHF14/78UFVAL	162	6.38	42	1.65	32	1.26
12.5	1/2"	14/ SAE	ISO 8434-2	1-1/16"-12 UN MALE BULKHEAD JIC	3CFHF14/34UNFF	123.7	4.87	42	1.65	32	1.26
12.5	1/2"	F NPTF	ANSI B1.20.3	NPTF 1/2" FEMALE	3CFHF12NPT F T	106.2	4.18	42	1.65	27	1.06
12.5	1/2"	12/ SAE	ISO 8434-3	1"-14 UNS MALE BULKHEAD ORFS	3CFHF12/1UNSFU	129.2	5.09	42	1.65	32	1.26
12.5	1/2"	12/ SAE	ISO 8434-3	1"-14 UNS MALE BULKHEAD ORFS	3CFHF12/1UNS F	129.2	5.09	42	1.65	32	1.26
12.5	1/2"	01/ SAE	ISO 11926-3	7/8"-14 UNF MALE	3CFHF1/78UNF F	107.4	4.23	42	1.65	32	1.26
12.5	1/2"	01/ METRIC	ISO 6149-2	M22x1.5 MALE	3CFHF1/2215FJDC	109.7	4.32	40	1.57	38	1.5
12.5	1/2"	01/ METRIC	ISO 6149-2	M22x1.5 MALE	3CFHF1/2215F B	109.7	4.32	42	1.65	32	1.26
12.5	1/2"	04/ BSPP	ISO 8434-6	BSPP 3/8 MALE BULKHEAD	3CFHF0874/38GF	108.2	4.26	42	1.65	32	1.26
12.5	1/2"	07/ METRIC	ISO 8434-1-L	M26x1.5 MALE BULKHEAD SHORT 18L	3CFHF087/2615F	125.2	4.93	42	1.65	32	1.26
12.5	1/2"	07/ METRIC	ISO 8434-1-L	M22x1.5 MALE BULKHEAD SHORT 15L	3CFHF087/22FAG	137.6	5.42	40	1.57	38	1.5
12.5	1/2"	22/ BSPP	BS 5200	BSPP 1/2 MALE	3CFHF0822/12G FL	111.2	4.38	38	1.5	32	1.26
12.5	1/2"	21/ BSPP	ISO 1179-2	1/8" BSPP MALE	3CFHF0821/18FU	108.7	4.28	42	1.65	32	1.26
12.5	1/2"	01/ BSPP	BS 5380	G 5/8"	3CFHF081/58S F	108.7	4.28	42	1.65	32	1.26
12.5	1/2"	01/ BSPP	BS 5380	G 1/2"	3CFHF081/12G F	109.7	4.32	42	1.65	32	1.26
12.5	1/2"	08/ METRIC	ISO 8434-1-S	M24x1.5 MALE BULKHEAD SHORT 16S	3CFHF 8/2415 F	120.4	4.74	42	1.65	32	1.26
12.5	1/2"	0/ SAE	ISO 11926-1	3/4" - 16 UNF FEMALE ORB	3CFHF 34 UNF F	106.2	4.18	42	1.65	27	1.06
12.5	1/2"	01/ SAE	ISO 11926-3	1-1/16"-12 UN MALE	3CFHF1/34UNF F	123.7	4.87	42	1.65	32	1.26
12.5	1/2"	01/ METRIC	ISO 6149-2	M22x1.5 MALE	3CFHF1/2215F A	109.7	4.32	42	1.65	32	1.26
12.5	1/2"	01/ METRIC	ISO 6149-2	M22x1.5 MALE	3CFHF1/2215 FAG	109.7	4.32	42	1.65	32	1.26
12.5	1/2"	11/ SAE	ISO 8434-3	13/16"-16 UN MALE ORFS	3CFHF0811/12SFJ	110.2	4.34	40	1.57	38	1.50
12.5	1/2"	02/ METRIC	ISO 8434-1-L	M22x1.5 MALE 15L	3CFHF082/22F D	116.9	4.60	42	1.65	32	1.26
12.5	1/2"	07/ METRIC	ISO 8434-1-L	M18x1.5 MALE BULKHEAD SHORT 12L	3CFHF087/18F U	122.4	4.82	42	1.65	32	1.26
12.5	1/2"	07/ METRIC	ISO 8434-1-L	M22x1.5 MALE BULKHEAD SHORT 15L	3CFHF087/22F U	122.4	4.82	42	1.65	32	1.26
12.5	1/2"	01/ METRIC	ISO 6149-2	M22x1.5 MALE	3CFHF1/2215F C	109.7	4.32	40	1.57	38	1.50

3CFHF

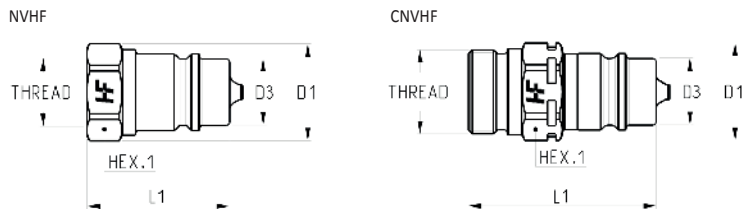

Size		Thread details			MALE									
mm	inch	Thread Type	Standard	Thread	Part Number	L (L1 + Thread)		D1		D3		HEX1		
						mm	inch	mm	inch	mm	inch	mm	inch	
12.5	1/2"	F BSPP	ISO 1179-1	BSPP 1/2 FEMALE	NVHF08 GAS M	44	1.73	30	1.18	20.5	0.81	27	1.06	
12.5	1/2"	F BSPP	ISO 1179-1	BSPP 3/8 FEMALE	CNVHF08 38GAS M	57	2.24	30	1.18	20.5	0.81	27	1.06	
12.5	1/2"	O2/ METRIC	ISO 8434-1-L	M18x1.5 MALE 12L	CNVHF082/1815 M	57	2.24	30	1.18	20.5	0.81	27	1.06	
12.5	1/2"	O2/ METRIC	ISO 8434-1-L	M22x1.5 MALE 15L	CNVHF082/2215 M	58	2.28	30	1.18	20.5	0.81	27	1.06	
12.5	1/2"	O2/ METRIC	ISO 8434-1-L	M26x1.5 MALE 18L	CNVHF082/2615 M	58	2.28	30	1.18	20.5	0.81	27	1.06	

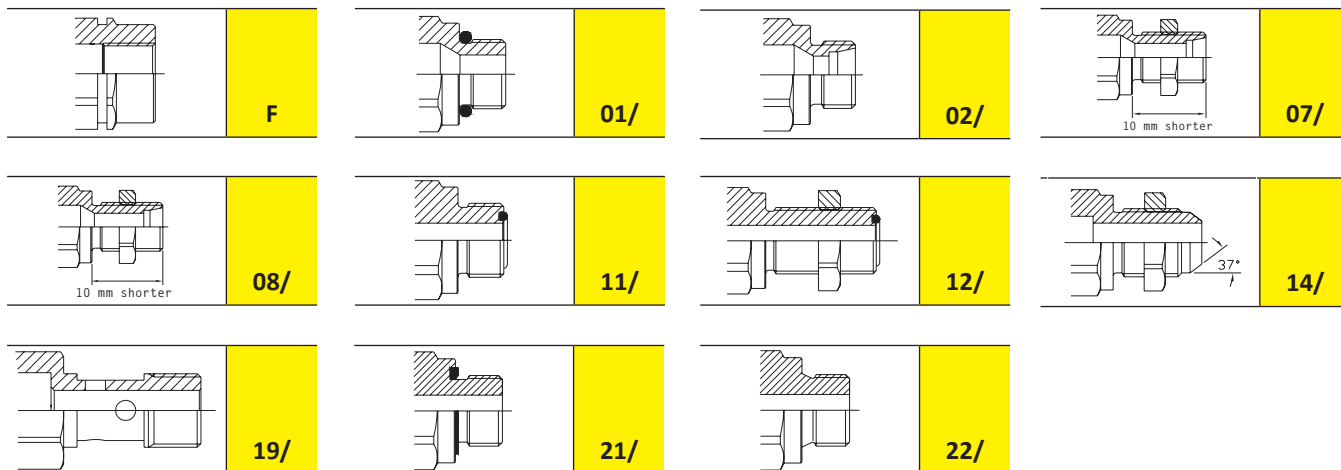

3CFHF Accessories and Spares



PVC dust protections



Acetal Resin dust protections

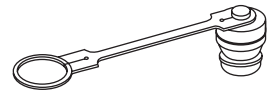

Aluminium dust protections

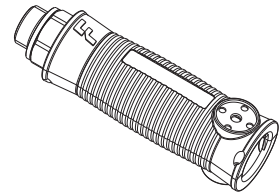

Line Identification System

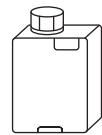
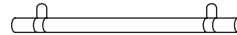
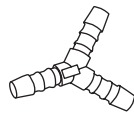
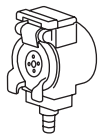

Modular automatic caps with Oil Collecting System



Seals Kits